

HiFi ENGINE®

For more Hi-Fi manuals and set-up information
please visit www.hifiengine.com

YAMAHA

CR-420



AM/FM Stereo Receiver

Owner's Manual

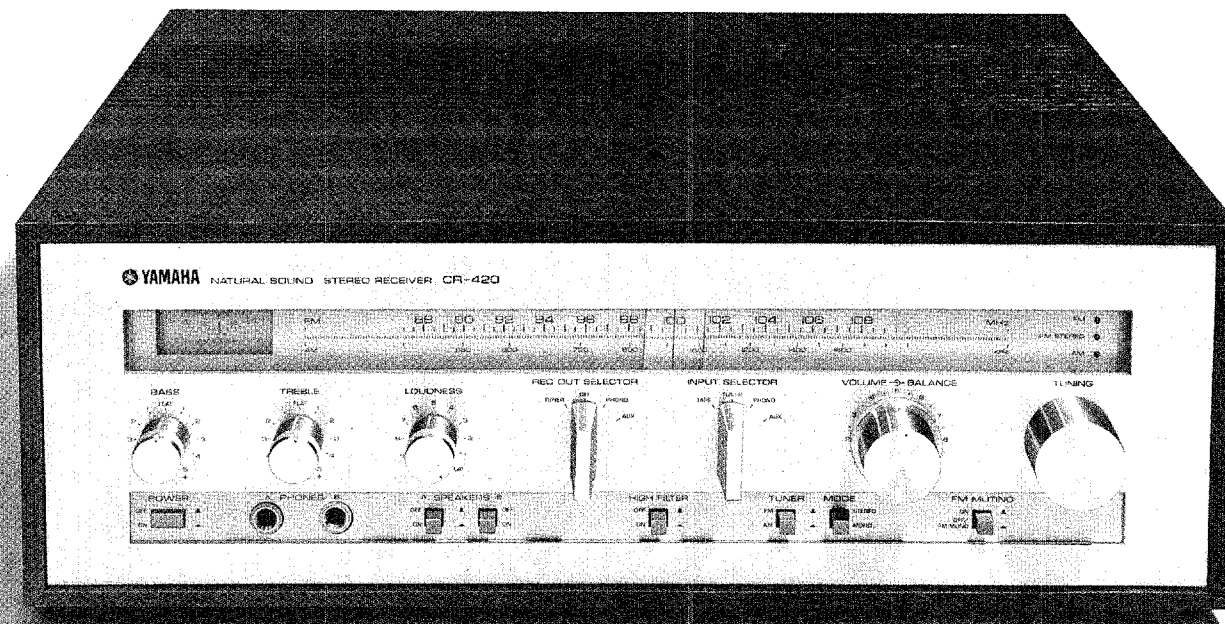
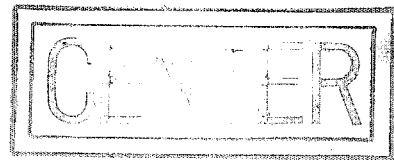

CR-420

CONNECTION DIAGRAM

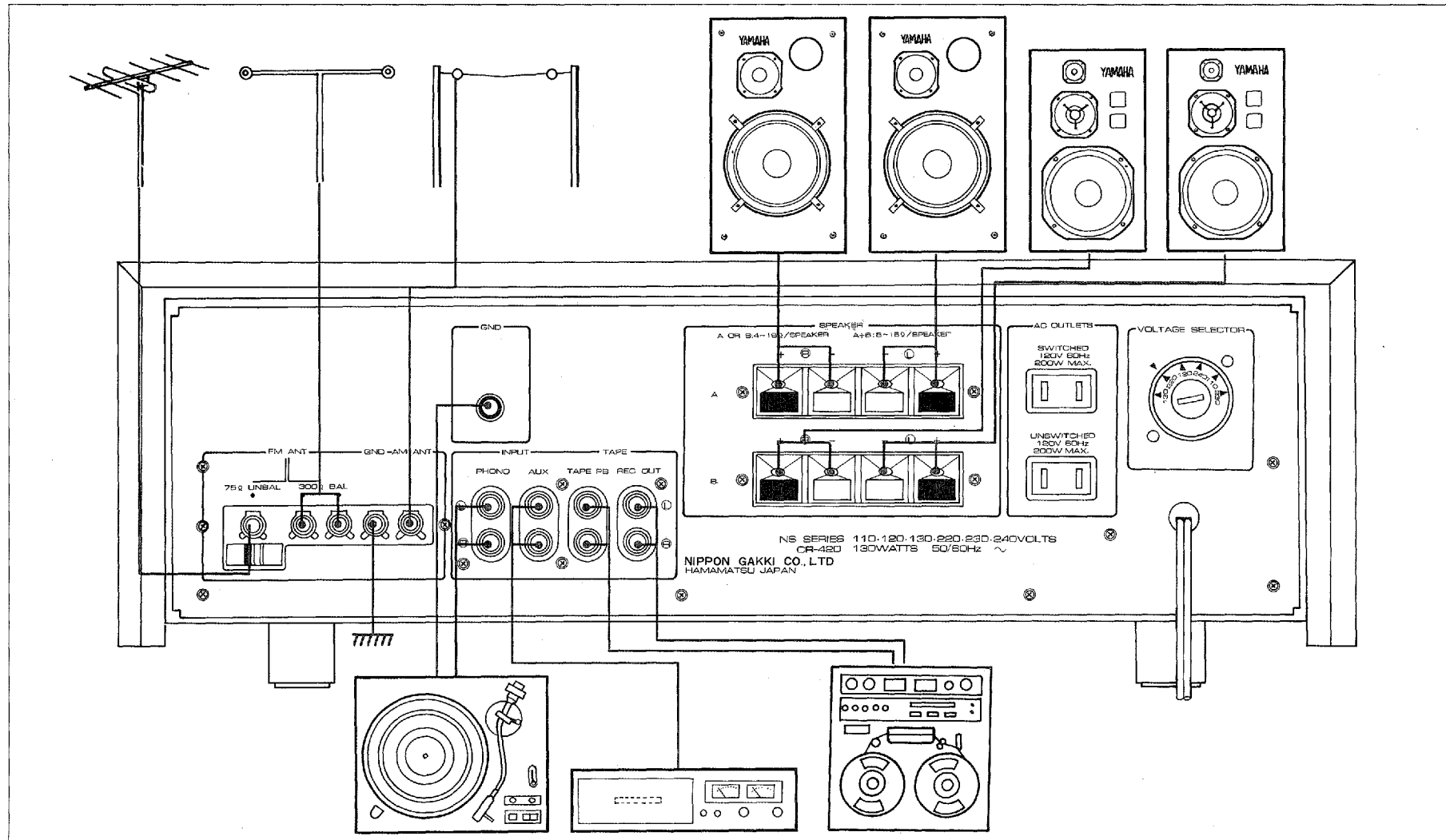

▼ FRONT PANEL Front panel numbers are explained on pages 6 and 7.

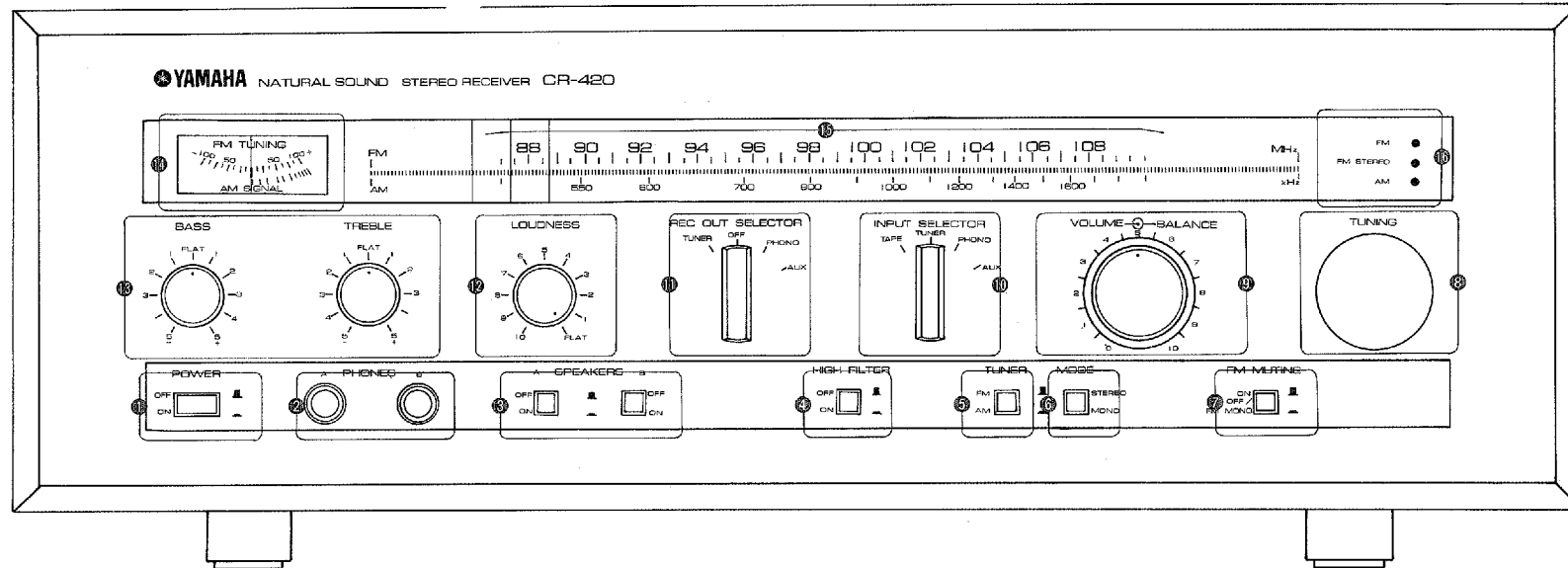

▼ REAR PANEL Rear panel numbers are explained on pages 8 and 9.

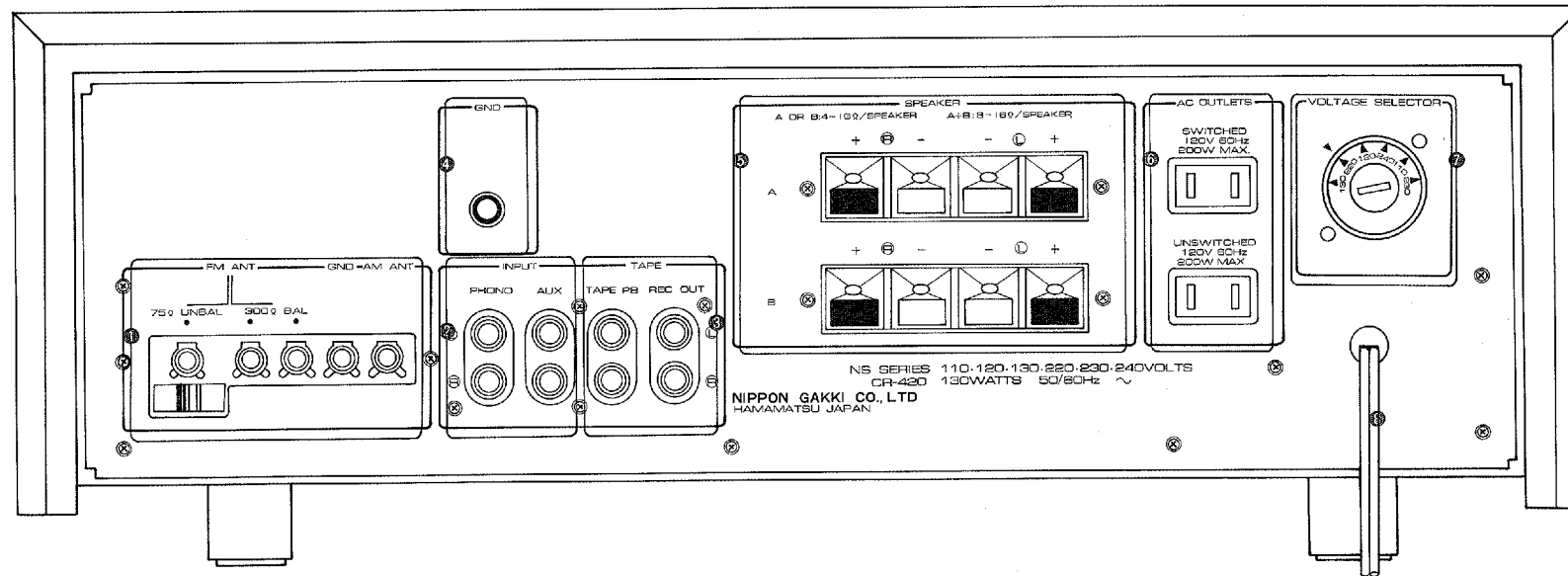

▼ Australian Model

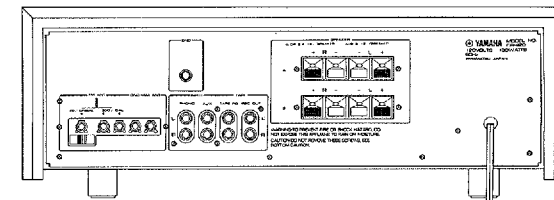

CR-420

CONTENTS

YAMAHA offers you thanks and congratulations on your choice of the CR-420 Receiver. Embodying novel and useful features, it combines superb broadcast reception with the finest audio quality, and is currently setting new standards for receiver performance in its class.

Caution — Read This Before Operating Your CR-420	5
Front Panel and Controls	6
Rear Panel and Connections	8
Broadcast Reception	10
Listening to Records	12
LOUDNESS, FILTER, and TONE Controls	13
The Special REC OUT Selector Switch and Tape Playback and Recording	14
Block Diagram	16
Circuit Diagram	17
Specifications	18
Trouble Shooting	20

SPECIAL FEATURES OF THE CR-420 RECEIVER

1. All-in-One Excellence

Accurately matched performance specifications, functions, and controls, give overall performance which fully measures up to Yamaha's high standards for separate tuners, pre- and power amps.

2. Noise-Distortion Clearance Range

The CR-420 offers an extremely wide range of output powers for which both noise and distortion are below the rated value, for the widest possible dynamic range in actual use. This was the basic design concept for the audio section.

3. Direct Assessment of Differential Gain

This sophisticated technique enables Yamaha to combine high station-getting ability, razor-sharp tuning, and ultra-low distortion in the tuner section.

4. Outstanding Receiver Cost/Performance

Yamaha's high-efficiency design policy, based upon extra-high level circuit technology, has allowed us to build in superb performance in relation to the CR-420's cost.

5. Durable, Easy-Action Selector Switches

The switches operated by the CR-420 Input Selector and Rec Out Selector are specially designed for smooth, positive action and years of dependability.

6. Continuous Loudness Compensation

Whatever your normal maximum listening level, this Yamaha 'special' enables full compensation for the ears' reduced sensitivity to bass and treble frequencies at lower listening levels.

CR-420

CAUTIONS — READ THIS BEFORE OPERATING YOUR CR-420

1

The CR-420 is a high performance AM/FM stereo receiver, with excellent selectivity, sensitivity, low distortion. This manual is required reading if you are to get the best from its special features and controls.

2

Do not drop or otherwise jar the CR-420, which is a precision electronic instrument.

3

Do not place the CR-420 where it will be exposed to direct sunlight, excessive heat (for instance over a radiator), cold, moisture, or dust.

4

Do not use chemical solvents (such as benzene or alcohol) to remove traces of dirt. Wipe only with a soft, slightly damp cloth.

5

Do not attempt to carry out internal adjustments or repairs. Leave these to your local service representative.

6

Do not assume your CR-420 is faulty before checking 'Trouble Shooting' list provided on pages 20~21.

7

Operate all switches and knobs in accordance with the instructions. Avoid applying undue force, which should never be necessary, and do not attempt to use intermediate settings.

8

Note that a muting circuit keeps the CR-420 silent for several seconds after switching ON, to prevent the pops and clicks that can occur.

9

Do not connect other audio equipment to the spare AC outlet sockets on the rear panel if it will require more power than the outlets are rated to provide.

10

Before switching on your CR-420, check that the voltage selector is set to your local supply voltage. Voltages available are 110/120/130/220/230/240V AC.

11

Keep this manual in a safe place for future reference, and refer to it frequently until you are perfectly familiar with all CR-420 controls and functions.

CR-420

FRONT PANEL AND CONTROLS

① POWER ON/OFF Switch

Turn this switch to ON to connect the main electrical supply, but leave the power switch OFF while familiarizing yourself with the various controls, and while you are connecting other audio equipment.

② PHONES A/B Jacks

Two headphone jacks are provided under the plastic cover. Plugging into the jacks does not cut-off power output to the speakers, so it is necessary to use the OFF positions of the SPEAKERS push-buttons if you do not want the speakers to function.

③ SPEAKERS A/B

These push-buttons select either or both of two pairs of stereo speakers (or neither, for headphone listening).

④ HIGH FILTER Switch

The HIGH filter has a 6 dB/octave cut-off slope at frequencies above 10 kHz.

⑤ TUNER FM/AM Switch

This determines whether AM (medium waveband) or FM stations will be received.

⑥ MODE Switch

This gives the choice of stereo or monaural reproduction. Note that in the MONO position the amplifier section will reproduce all sources (including FM stereo programs, etc.) monaurally. However, even in the STEREO mode, FM stereo programs will be reproduced monaurally if the MUTING switch is OFF.

⑦ FM MUTING: ON/OFF FM MONO

With this switch in the ON position, the muting system will cut out (suppress) weak stations and background noise interference and will ensure continued optimum reception of FM stations. In the OFF position, only monaural FM reception will be possible. The FM MUTING functions by ensuring that both inter-station noise and weak signal strength stations will be muted at input signal levels below 5 μ V. In the OFF position, even the weakest stations will be heard, but only in the monaural mode.

⑧ TUNING Control

This large tuning knob gives smooth and positive station selection, with the precision flywheel mechanism preventing backlash. Also, the tuning circuits utilize a wide air-gap high precision three-gang variable capacitor, providing great sensitivity and high stability.

⑨ VOLUME and BALANCE Controls

Use the VOLUME control to adjust the speaker output to give the volume of sound that you require. Always start operation with the VOLUME control turned fully to the left (counter-clockwise) at the '0' position before turning it up to the volume level you require.

The BALANCE knob controls the difference in output volume between the L and R (left and right) stereo channels. Set this control to the center '5' position, at which there is a click stop, unless you need to correct for a lack of balance between the audio output of the two channels, or to correct for a listening position which is not equidistant from the two speakers. The BALANCE control reduces the volume from the left-hand speaker when turned clockwise, and reduces that from the right-hand speaker when turned counter-clockwise.

⑩ The INPUT SELECTOR Switch

This selector switch is used to select the program source of your choice, whether it be PHONO, TUNER, TAPE deck, or AUX (for use with 8-track tape cartridge playback, etc.). The PHONO switch position input circuit is designed to operate with normal moving magnet (MM) type cartridges.

Use of some moving coil (MC) type cartridges is possible, but other low output moving coil cartridges may require use of a step-up transformer or a head amplifier.

⑪ REC OUT Selector

This selects which program source will be recorded, just as the INPUT SELECTOR selects which program source will be heard. With the CR-420, you can listen to one program source while recording any other (copy a friend's tape while listening to FM, etc). This eliminates "dead" time while you are taping, permitting you to enjoy the use of your CR-420 while recording.

⑫ The LOUDNESS Control

This boosts the extreme low and high frequencies to compensate for our ears' reduced sensitivity to these frequencies at low volumes. Set it to the FLAT position while the VOLUME control is set to your highest normal listening level. Turning the control counter-clockwise will reduce the volume but will retain the natural balance between low and high frequencies.

⑬ BASS and TREBLE Controls

The bass and treble controls have a low turnover frequency of 350 Hz and a high turnover frequency of 3.5 kHz respectively.

⑭ FM TUNING/AM SIGNAL METER

This meter fulfills two functions. When the TUNER switch is set to FM, it functions as an FM tuning meter, and when the switch is set to AM, as an AM signal meter.

⑮ FM/AM Tuning Scale

The upper scale gives FM station frequencies in MHz and the lower scale gives AM frequencies in kHz. On the left-hand side of the front panel, the upper LED lights to indicate FM operation and the lower LED lights to show AM operation.

⑯ LED Indicators

The top light-emitting diode is the FM indicator, the bottom one is the AM indicator. When the POWER switch is on, one of these two will light up, depending on the setting of the TUNER switch.

The center LED lights when a stereo broadcast is received.

CR-420

REAR PANEL AND CONNECTIONS

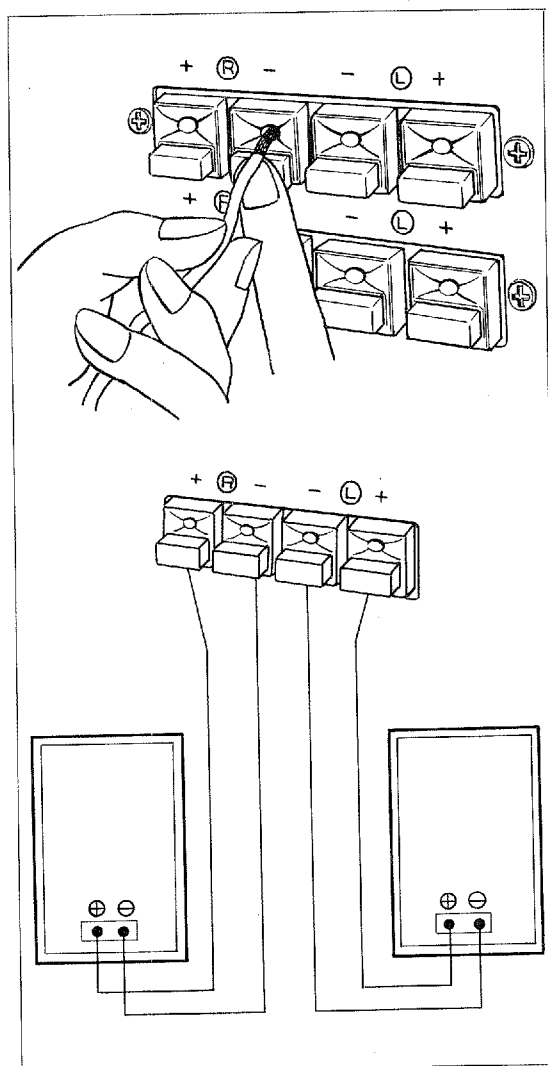

1 Antenna Connections

Detailed instructions on AM and FM reception are given on pages 10 to 11, but a quick check of CR-420 functions can be carried out by connecting the T-type internal (indoor) antenna provided with the CR-420 to the terminals marked 300 Ω BAL. Attach the two arms of the 'T,' fully extended, to the ceiling or walls of your room after finding the best orientation. Note that such a quick check can be carried out with the selector switches vertical and all push-button switches in the out (non-depressed) positions, except for the SPEAKERS selector buttons (when you wish to hear the output on your speakers rather than using headphones).

2 INPUT Terminals

These are the terminals which are selected by the INPUT SELECTOR switch on the front panel. They include PHONO and AUX connections. The AUX terminals can be used to connect an external tuner, or for 8-track cartridge tape playback, etc.

3 TAPE PB and REC OUT Terminals

A tape deck can be attached to these input and output terminals. Any source connected to the CR-420 can be recorded on this deck, by setting

the REC OUT selector switch on the front panel to the appropriate position.

Recording can proceed while any other source selected by the INPUT SELECTOR is being auditioned.

4 GND (Ground) Terminal

This ground terminal is provided for the grounding of turntable units, etc. Please make sure that all such units are firmly grounded: failure to connect the ground leads can result in unpleasant hum.

5 SPEAKERS Terminals

The CR-420 can handle two sets of speakers (A or B), with selection of either, both, or neither, by use of the SPEAKERS push-buttons on the front panel. Speakers should have impedances between 4 and 16 ohms, but with two speaker sets being used at the same time, connect only speakers with impedances between 8 ohms and 16 ohms. Use speakers rated to take the full 22 Watts of output power, or set the VOLUME control so that the rated maximum speaker input power is not exceeded. Volume level should be reduced immediately if there is increased distortion or a sense of strain which indicates that the speakers are being overloaded.

Making the Speaker Connections

1. Strip the insulation from the speaker cable for 1/2" (10 mm), and twist stray ends together. If possible, solder the ends. Push the lever beneath the terminal as shown in the diagram, and align the inner and outer terminal holes. Then insert the wire fully home. Release the lever, and the wire end will be firmly clamped.
2. Use the upper (A) terminals first. Be careful that the terminals identified by the + and - signs above them are connected with the corresponding + and - terminals on the speakers. A mistake will result in poor bass response and ill-defined stereo image. Also be sure to connect the left-hand speaker to the L speaker terminals, and the right-hand to the R terminals.
3. Repeat this with the B terminals if other speakers are to be connected. In all cases make sure that connections are fully and firmly made, or you may not be able to get any sound from one or more speakers.

⑥ AC OUTLETS

These spare AC OUTLETS are provided for your convenience in connecting other items of audio equipment. Only the top outlet is controlled by the CR-420 POWER switch. This has a maximum power rating of 200 Watts, and should be used for items such as turntable units. Do not connect any item which draws more than 200 Watts. The lower outlets are not affected by the CR-420 POWER switch, and any items connected to them must be switched on and off with their own switches in the normal way. Note that the total power available is only 200 Watts. Use them for, say, your tape deck or decks.

⑦ VOLTAGE SELECTOR

The voltage selector must be set to your local AC mains supply voltage. If the precise voltage is not available, use the voltage immediately above. Using an incorrect voltage setting will mean either inferior performance or severe damage to your CR-420.

⑧ AC Electrical Power Line

Plug the CR-420 power cord into a main power supply wall outlet socket, and make sure the line is not likely to be tripped over.

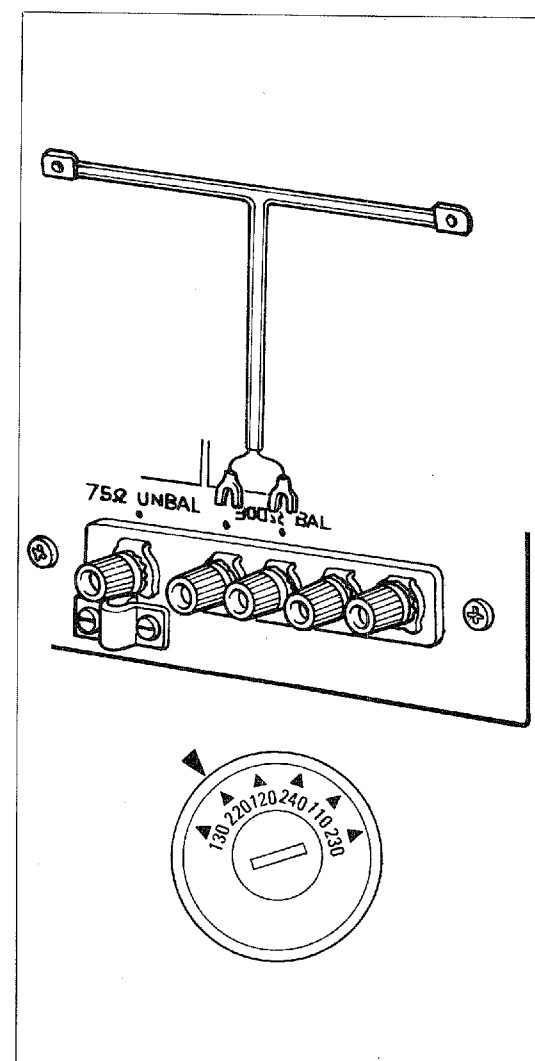

CR-420

BROADCAST RECEPTION

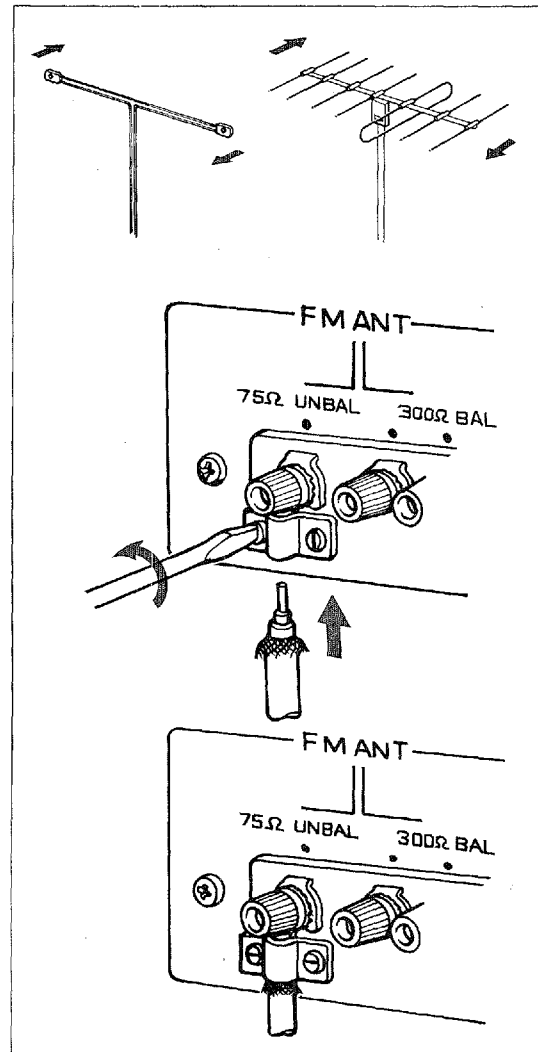

CONNECTING AN FM ANTENNA

The T-type antenna provided with your CR-420 is adequate only in high signal strength areas and under favorable conditions. In other cases, an external multi-element FM antenna is needed. If you cannot obtain satisfactory reception with the T-type antenna, this is an indication that you need an external FM antenna.

The external antenna should preferably be located fairly close to the CR-420, and mounted as high as conveniently possible. Try various antenna orientations, either pointing towards the weakest station you intend to receive or away from the major source of interference (preferably both, although some compromise is usually necessary in most locations).

If the antenna is intended for use with shielded coaxial cable (which reduces losses and interference) use the 75 Ω UNBAL terminals on the rear panel of the CR-420, and connect the cable as shown. If the coaxial cable has a coaxial plug connection, you may simply plug this into the socket provided. Antennas intended for use with the 300 Ω BAL terminals on the rear panel (which use feeder wire similar to that of the internal antenna provided) can also be used with coaxial cable if a matching transformer is attached to the antenna. The use of coaxial cable is advisable where the antenna must be located some distance from the CR-420, or where interference from automobile ignition, etc., is troublesome.

CONNECTING COAXIAL CABLE

1. Strip the insulation from outside the braided sheath, and bend back the metal braiding *outside* the insulation. Expose the projecting central core wire as shown. Be careful not to cut through any strands.
2. Slacken the two retaining screws as shown and insert the coaxial cable.
3. Re-tighten the screws so that the clip grips the exposed braided sheath.
4. Connect the central core wire to the 75 Ω terminal.
5. Ensure that the braiding does not come into contact with the inner core.

FM BROADCAST RECEPTION

1. Set the INPUT SELECTOR to TUNER.
2. Set the TUNER push-button to FM.
3. Check that the FM indicator LED lights at the right-hand side of the dial.
4. All switches and knobs should be as shown in the front-panel diagram (with all push-buttons OUT except for the use of the SPEAKERS selection buttons if you wish to use speaker output rather than headphones).
5. Set the Tuning Indicator to the frequency (MHz) of the station you want to listen to. Precise tuning is accomplished by watching

the FM tuning meter, and centering the needle exactly in the middle.

6. Now tune to bring the FM TUNING meter pointer to the exact center. This is the optimum tuning position: set it carefully.
7. Check that the FM STEREO indicating LED on the right-hand side of the dial lights if you intend listening to a stereo rather than a monaural broadcast.

FM MUTING: ON/OFF-FM MONO SWITCH

This push-button switch should normally be left in the ON (non-depressed) position.

In the recommended FM MUTING ON position, the weakest stations will be cut out (muted), together with the inter-station noise. You will be able to tune from station to station, free of background noise and remote, very poor quality stations. This muting circuit is adjusted to eliminate all signal inputs to the CR-420 which are below a threshold value of $5 \mu\text{V}$.

If a reduction in noise becomes desirable while you are tuned to a specific FM stereo station, press the FM MUTING push-button to the OFF position.

The program will be heard with a marked improvement in signal-to-noise ratio, but will revert to the MONO mode. (Note: the stereo program will be heard in the MONO mode although the MODE push-button remains at the STEREO position.)

AM RECEPTION

First set the TUNER FM/AM switch to AM, and set the tuning indicator to the desired station frequency. Adjust the tuning knob to give the maximum SIGNAL meter reading.

1. Set the TUNER switch to AM (the AM indicator on the right side of the dial scale will light).
2. Set the Tuning Indicator to the frequency (kHz) of the station you want to listen to. Precise tuning is accomplished by watching the AM signal meter, and tuning to give the maximum reading.

Note: In the AM mode, the meter dial functions differently than it does in FM; it does not swing left or right from the center.

3. The CR-420's AM bar antenna assures enough sensitivity for clear reception of ordinary AM broadcasting. In areas where reception is poor, due to interference or distance from stations, clear reception is possible by connecting an external antenna and earth ground to the AM ANT-GND terminal on the rear panel.

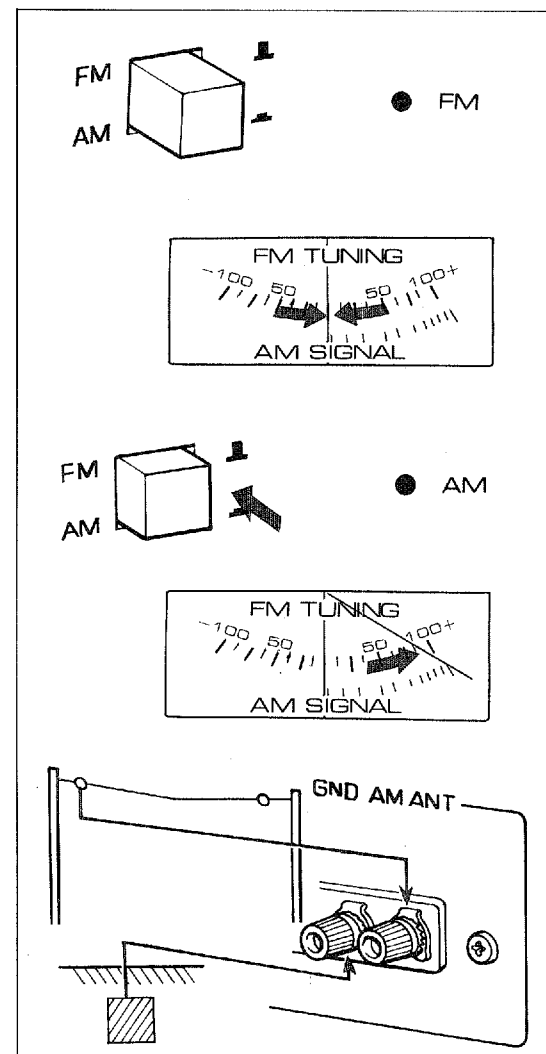

CONNECTING A TURNTABLE UNIT

The main AC supply plug of your turntable unit may usually be conveniently inserted into the spare AC outlet socket controlled by the CR-420 POWER switch. With some turntables it is important not to disconnect the main supply without first switching off at the turntable itself (read the turntable instruction manual to check).

In this case you should use the *unswitched* spare AC outlet. The pin plugs on the output lead from the turntable unit should be connected to the PHONO terminal pin jacks at the left-hand side of the back panel. Check that the L and R pin plugs (for the left and right channels) have been correctly inserted. Do not forget to connect the turntable ground line to the GND terminal on the CR-420 rear panel.

Switch on the receiver POWER switch, and set the INPUT SELECTOR switch to PHONO. The PHONO input circuit is intended for use with standard moving magnet (MM), moving iron (MI)

or induced magnet (IM) type cartridges. Certain moving coil (MC) cartridges can also be used, but some have output levels too low for satisfactory performance without the use of a step-up transformer or head amplifier. Note that the PHONO input pin-plugs should never be connected or disconnected while the POWER switch is ON.

Always switch off your speakers by releasing the SPEAKERS push-button when raising or lowering the cartridge stylus over the record to prevent overloading and possible damage.

If you play monaural records, the signal-to-noise ratio will be improved if you turn the MODE selector to the MONO position.

If you notice a low-pitched rumble when playing records, cut this out with the LOW filter. Similarly you can use the HIGH filter to reduce unpleasant surface noise or record 'scratch.' Use the BASS and TREBLE, controls to give the best tonal balance, and use the LOUDNESS volume control rather than the main volume control to reduce listening levels below your normal maximum.

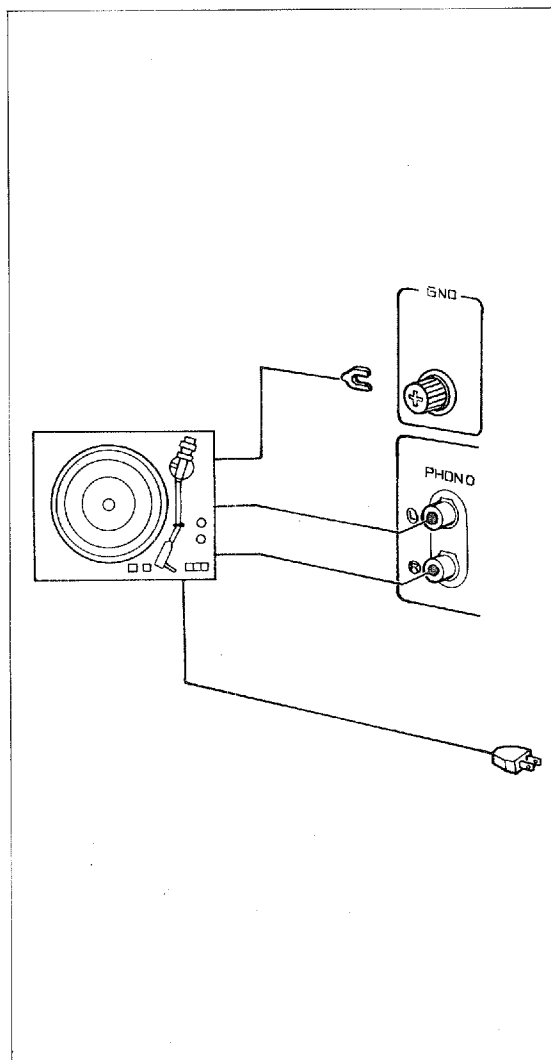

CR-420

LOUDNESS, FILTER, AND TONE CONTROLS

CONTINUOUS LOUDNESS CONTROL

Set this to the *FLAT* position (not the mid-point '5') when listening at normal high levels. The *LOUDNESS* compensation curves shown enable the same subjective tonal balance to be retained as this control is turned down, unlike the *VOLUME* control itself, for listening at lower levels.

HIGH FILTER

By setting the *HIGH FILTER* switch on, you can cancel the frequencies over 10 kHz at 6 dB/octave. This is useful for cutting tape hiss and noise from record scratches. The CR-420 also incorporates a Subsonic Filter which cancels the extremely low frequency range below 15 Hz at 12 dB/octave, thus eliminating noises which may be harmful to speakers.

COMPREHENSIVE TONE CONTROLS

The carefully chosen turnover frequencies of the bass and treble tone controls have optimum influence at the higher and lower frequencies for major correction of tonal character.

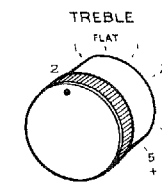
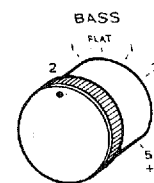
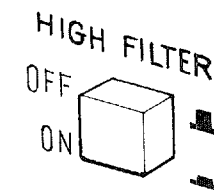
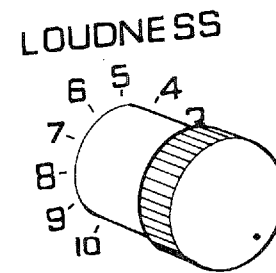
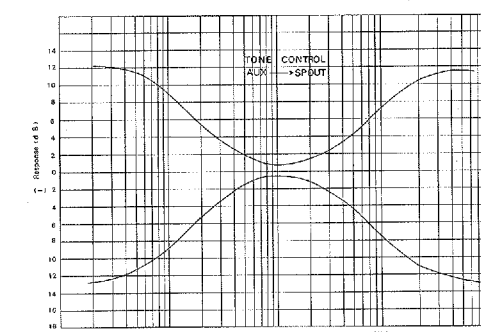
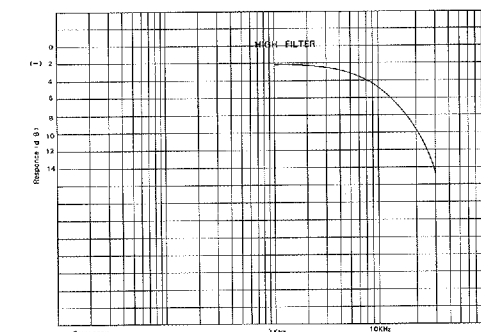
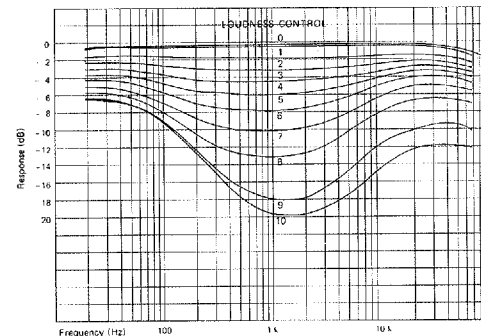

CR-420

THE SPECIAL REC OUT SELECTOR SWITCH, TAPE PLAYBACK AND RECORDING

Recording One Program Source While Listening to Another

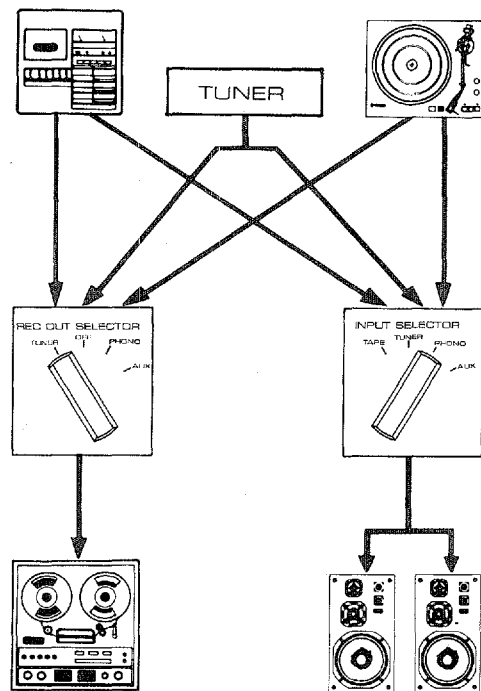

INDEPENDENT AUDITION AND RECORDING

Do not confuse the REC OUT SELECTOR and INPUT SELECTOR switches. The INPUT SELECTOR switch decides which program source you hear. The REC OUT SELECTOR switch decides which one you record. Yamaha receivers are at present unique in offering independent choice of audition and recording. Thus, for example, you can listen to a record while tape recording direct from the AM/FM tuner section.

TAPE DECK CONNECTIONS/PLAYBACK

The output leads provided with the tape deck are used to connect the tape deck LINE output terminals to the TAPE PB terminals on the rear panel of the CR-420. Set the INPUT SELECTOR to TAPE to play back tapes. Use the output level controls on the tape deck or decks to adjust the playback level so that there is no great change in volume level when switching between TUNER and TAPE terminals.

TAPE DECK CONNECTIONS/RECORDING

The tape-deck leads provided are used to connect

the deck LINE input terminals to the REC OUT terminals.

Note that the INPUT SELECTOR switch setting has *no effect whatever* upon the signal which will be recorded via these REC OUT terminals. The REC OUT terminals' output signal is decided by the REC OUT selector switch. If you refer to the description of the REC OUT function on the previous page you will see that the recording of any of the program sources connected to the CR-420 is possible: just set the REC OUT switch to TUNER, PHONO, or AUX, as you wish.

Recording of any of these sources can proceed while that source, or any other, is selected for audition by the INPUT SELECTOR switch. Monitoring of the recording while it is in progress can also be carried out if you are using a three-head deck designed for monitoring. Just set the INPUT SELECTOR switch to the TAPE position via which you are recording.

The level at which a tape recording is made is very important: for full details of recording techniques you should consult the instruction manual provided with your tape deck. Adjustments in level must be made with the input level controls on the tape deck. Note that the signals from the REC OUT terminals which are recorded by your tape deck are not influenced at all by settings of the tone, filter, and volume controls, etc., on the front panel of the CR-420, and all such tonal and other

adjustments must be made on playback. If you record at too low a level you will notice a high level of tape 'hiss' on playback, and if the level is too high, the peak volume levels will be distorted and you may even have difficulty in erasing them later.

TAPE TO TAPE DUBBING

For tape-to-tape dubbing, you will need two decks. Connect tape deck LINE output, which will be the program source, to the AUX terminals of the rear panel of the CR-420, and recording-tape deck LINE input to the REC OUT terminals. Set the INPUT SELECTOR to the AUX position, the REC OUT SELECTOR to the AUX position, and you can complete tape-to-tape dubbing. If there is a difference in the quality of the decks, the best results will be often obtained if the better deck is used for the recording rather than for the playback. Check by making brief recordings in both directions and by comparing the resulting quality of playback. Check carefully that the L (left) and R (right) channel pin-jacks have been correctly connected

before commencing to dub. Recording of any of these sources can proceed while that source, or any other, is selected for audition by the INPUT SELECTOR switch. Monitoring of the recording while it is in progress can also be carried out if you are using a three-head deck designed for monitoring. Just set the INPUT SELECTOR switch to the TAPE position via which you are recording.

The level at which a tape recording is made is very important: for full details of recording techniques you should consult the instruction manual provided with your tape deck. Adjustments in level must be made with the input level controls on the tape deck. Note that the signals from the REC OUT terminals which are recorded by your tape deck are not influenced at all by settings of the tone, filter, and volume controls, etc., on the front panel of the CR-420, and all such tonal and other adjustments must be made on playback. If you record at too low a level you will notice a high level of tape 'hiss' on playback, and if the level is too high, the peak volume levels will be distorted and you may even have difficulty in erasing them later.

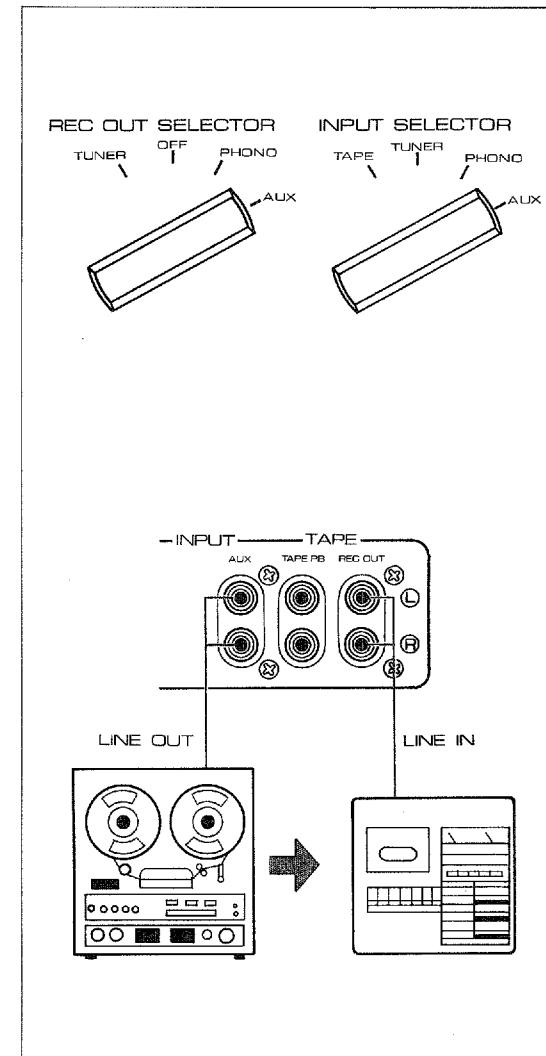
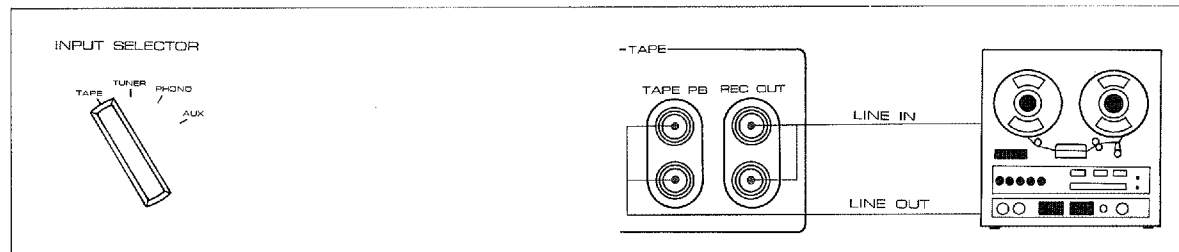

CR-420

BLOCK DIAGRAM

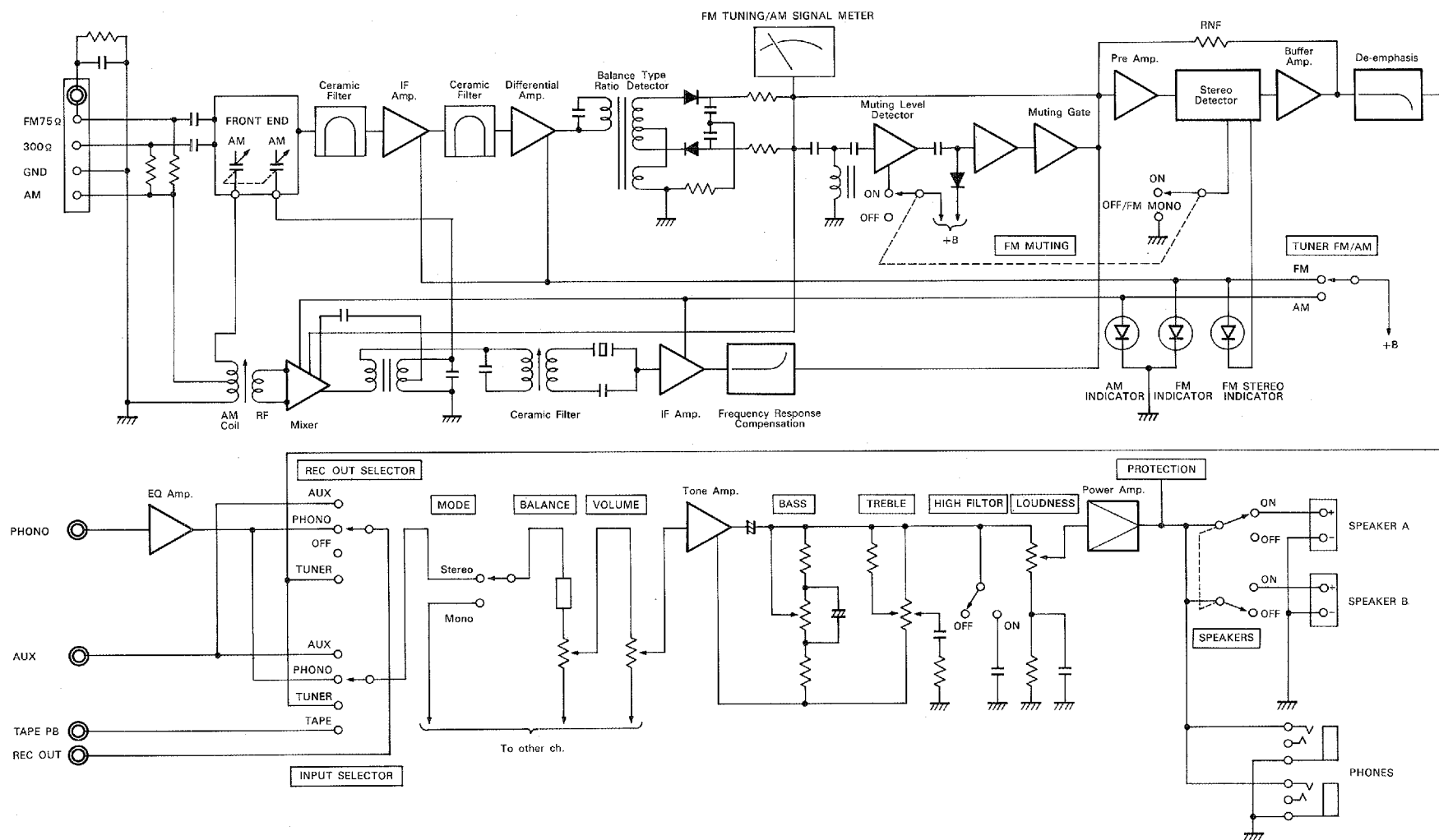

CR-420

CIRCUIT DIAGRAM

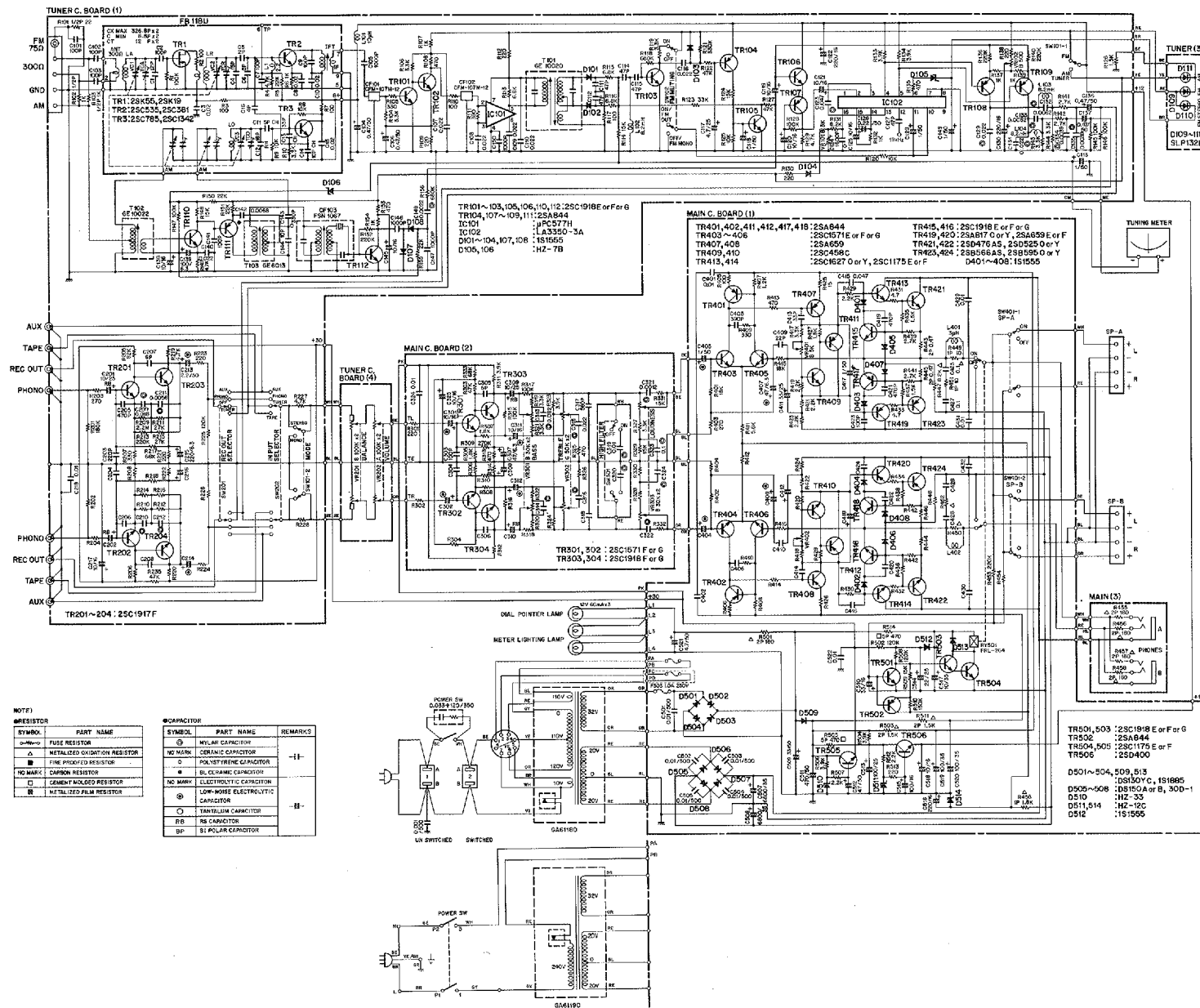

CR-420

SPECIFICATIONS

AUDIO SECTION

Minimum RMS Output Power per Channel

25 Watts (4 ohms) from 20 to 20,000 Hz at no more than 0.05% Total Harmonic Distortion

22 Watts (8 ohms) from 20 to 20,000 Hz at no more than 0.05% Total Harmonic Distortion

Continuous RMS power (8Ω)	25 Watts (driven at 1 kHz)
	22 Watts (driven at 10 ~ 40 kHz)
Input Sensitivity/Impedance	
Phono	2 mV/1 kHz 50 kΩ
Aux, Tape	120 mV/45 kΩ
Maximum Input Level	
Phono	110 mV at 1 kHz
Output Level/Impedance	
Rec Out terminals (Phono)	120 mV/220Ω (rated) 9V (max. 1 kHz)
(Tuner)	6 kΩ
Frequency Response	
Phono RIAA deviation	±0.5 dB
Aux, Tape 1, 2 to Sp Out	20 Hz to 20 kHz ± 1.5 dB
Tone Control Characteristics	
Bass turnover frequency	350 Hz
Bass boost/cut	±12 dB at 50 Hz
Treble turnover frequency	3.5 kHz
Treble boost/cut	±11 dB at 20 kHz
Filters and Loudness Control Characteristics	
Low (built-in)	10 Hz (12 dB/octave)
High	10 kHz (6 dB/octave)
Loudness control	Level-rated equalization
Signal-to-Noise Ratio (IHF-A Network)	
Phono	91 dB for 10 mV, Shorted
Aux, Tape	97 dB
Residual noise	0.14 mV

Distortion 20 Hz to 20 kHz	
Phono to Rec Out	0.05% 1.2V output
Aux, Tape to Sp Out (8Ω)	0.02% at 11W
	0.05% at 0.25 ~ 22W
Noise-Distortion Clearance Range (NDCR) for 0.1% into 8Ω at 20 ~ 20 kHz	
From 100 mW to 22 Watts with Vol -20 dB (Phono Input to Sp Out)	
IM Distortion Aux Sp Out	0.02% at 11W/8Ω
	0.05% at 0.25 ~ 22W/8Ω
Power Bandwidth (IHF)	10 Hz to 40 kHz
Damping factor (at 1 kHz)	Better than 40 into 8Ω
FM SECTION	
Tuning range	87.6 to 108 MHz
Usable Sensitivity (IHF MONO 84/98 MHz)	
300Ω	10.3 dBf/1.8 μV
75Ω	10.3 dBf/0.9 μV
Quieting Characteristics (for 50 dB signal-to-noise)	
Mono	16.1 dBf (3.5 μV)
Stereo	38 dBf (43.5 μV)
Image Rejection (84/98 MHz)	50 dB
IF Rejection (84/98 MHz)	75 dB
Supurious Rejection (84/98 MHz)	75 dB
AM Suppression (IHF)	56 dB
Capture Ratio	1.0 dB
Usable Selectivity (IHF)	65 dB

Signal-to-Noise Ratio (IHF)		
Mono		77 dB
Stereo		71 dB
Total Harmonic Distortion		
Mono	100 Hz	0.15%
	1 kHz	0.15%
	6 kHz	0.3%
Stereo	100 Hz	0.25%
	1 kHz	0.25%
	6 kHz	0.8%
Intermodulation Distortion (IHF)		
Mono		0.1%
Stereo		0.2%
Sub-Carrier Suppression		
		40 dB
Stereo Separation		
	50 Hz	30 dB
	1 kHz	40 dB
	10 kHz	30 dB
Frequency Response		
	50 Hz to 10 kHz	±0.5 dB
	30 Hz to 15 kHz	+1.0 –3.0 dB
Muting Level		
		19.2 dBf (5 μV)
AM SECTION		
Tuning Range		
		525 to 1,605 kHz

Sensitivity (IHF, bar antenna)		18 μV/m
Selectivity (1,000 kHz)		20 dB
Signal-to-Noise Ratio		50 dB (at 80 dB/m)
Image Rejection (1,000 kHz)		40 dB
IF Rejection (1,000 kHz)		40 dB
Spurious Rejection (1,000 kHz)		50 dB
Total Harmonic Distortion		0.6% (at 80 dB/m)
Tuner Section Output Level/Impedance		
	FM (100% mod. at Rec Out)	450 mV/6.5 kΩ
	AM (30% mod. at Rec Out)	120 mV/6.5 kΩ
GENERAL		
Semiconductors		53 Transistors, 2 ICs, 1 FET, 25 Diodes, 5 Zener Diodes, 3 LEDs, 2 Ceramic Filters
Power Supplies		AC 110/120/130/220/230/240 V, Switchable, 50/60 Hz Australia AC 240 V, 50 Hz
Power Consumption		130W (Aust. 200 W)
Dimensions (W x H x D)		451 x 161 x 324 (17-3/4" x 6-1/3" x 12-3/4")
Weight		9 kg (20 lbs.)

CR-420

TROUBLE SHOOTING

Before assuming that your CR-420 is faulty, check this trouble-shooting list. It details many steps you can take yourself without having to call a service representative.

AUDIO SECTION

Fault	Cause	Cure
No power although POWER switch in ON (POWER LED unlit).	AC power line not plugged-in to supply socket. AC main fuse has blown.	Plug firmly into the supply socket. Contact your service representative for a replacement.
No sound although power is connected.	Volume too low. INPUT SELECTOR in wrong position. Input pin plugs incorrectly inserted, loose, or disconnected. Speaker connections faulty. Both SPEAKERS push-buttons non-depressed.	Turn up volume. Check and change as necessary. Check and insert fully in the correct positions. Check and make good. Depress one or both (A, B, or A + B).
Sound comes only, or mainly, from either L or R speaker.	Speaker connections faulty. Input connections faulty. BALANCE control not properly adjusted.	Check and make good. Check and make good. Set to give correct stereo balance.
Sound suddenly ceases during audition.	The protective circuit has gone into operation. AC main fuse has blown.	Check for incorrect (too low) speaker impedances or short circuits and correct. If the fault persists, switch off and wait briefly before switching on again. Contact your service representative for a replacement.
Poor bass response and badly defined stereo image.	Speaker + and - connections are incorrect.	Reverse the connections to one speaker, not both.
A loud 'hum' is heard with or instead of, the record when attempting PHONO audition.	Either the pin-plugs from the phono cartridge are not firmly plugged into the input sockets, or the braided shielding wire is defective.	Plug in firmly, replacing the defective shielding if necessary. Check and make good the GND (ground) wire connection.
The volume control cannot be raised during record audition without a loud 'booming' noise.	This is caused by feedback of sound from the speakers to the phono cartridge stylus, and is called 'howling.'	Increase the separation between turntable unit and speakers, avoiding locations directly in line with the speakers.
Bass and treble frequencies are unnaturally exaggerated.	The LOUDNESS volume control is set too low.	Turn to the FLAT position (fully clockwise) and reset main and LOUDNESS volume controls according to the instructions.
Your tape recorder does not record the program you are monitoring.	The REC OUT selector is not set to the required program source.	Turn to the required setting.

TUNER SECTION

Fault	Cause	Cure
A persistent hum occurs when an AM station is tuned.	This modulation hum can affect whole areas where conditions are unfavorable.	Sometimes changing the position of the CR-420 will give an improvement.
Intermittent crackling or continuous background 'roaring' on AM.	Atmospheric electricity or electrical storms, possibly fluorescent lighting or other electrical equipment.	Difficult to eliminate, an external antenna and good ground connection will give considerable improvement.
High pitched whistles, etc., particularly at night on AM.	Signals from adjacent stations are interfering with reception.	Nothing can be done to cut out this interference completely but try the HIGH filter.
	The CR-420 is being operated too near a TV set.	Increase the separation between the TV and the CR-420
The desired station cannot be received at the correct frequency on the dial.	The station strength may be low, and the MUTING circuit may therefore prevent audition.	Switch the FM MUTING from ON to OFF.
A stereo station is heard monaurally.	The amplifier MODE switch is set to MONO. The FM MUTING switch is at OFF.	Push and release to the STEREO position. Switch it ON.
Occasional crackling interference (particularly with remote, weak signal stations).	Electrical noise from automobiles, etc., or from other electrical equipment.	Set up an external FM antenna, as high and as far from the road as convenient: use coaxial cable. Fit an interference suppressor to the offending item where possible.
Disturbing levels of 'hiss' noise when on FM stereo stations.	FM stereo broadcasts are inherently more liable to this at remote, low signal strength locations.	Set up an external FM antenna; if you are already using one, orient it towards the station or replace with a more sensitive array. Alternatively or additionally, listen with the FM MUTING switch set at OFF.
Local stations suffer from unclear, distorted sound.	Signal input from the antenna for these stations is too strong.	Connect an attenuator between the FM antenna and the CR-420, or turn the antenna away from the strongest (closest) station.
During stereo test transmissions, sounds which should come from only one channel can be heard faintly over the other.	This is known as crosstalk, and normally occurs to some extent.	Provided the sound level is very faint compared with the normal level for that channel, no fault is indicated.



SINCE 1887  **YAMAHA**
NIPPON GAKKI CO., LTD. HAMAMATSU, JAPAN

